

THETFORD



Hob 140-145 Series

User Manual

DECLARATION OF CONFORMITY

We: **THETFORD Ltd**

Address: Unit 6 Brookfields Way, Manvers, Rotherham, S63 5DL

Telephone: (+44) (0) 844 997 1960. Fax: (+44) (0) 844 997 1961

Declare under our sole responsibility that;

Product Types; Domestic build-in LP Gas and dual fuel cooking appliances;

Model Number/Description; SHB353xx Series Hobs & SCU353xxx Series Combination Hobs;
SHB33000 to SHB33099 Triangular Hobs & SHB34000 to SHB34599 Rectangular Hobs;
SHB140xx, SHB144xx, SHB143xx, SHB145xx & SHB142xx Series Argent Gas & Dual Fuel Hobs;
SHB174xx & SHB172xx Series Linear Gas & Dual Fuel Hobs;

Are in conformity with the relevant European Union harmonization legislation, Regulation (EU) 2016/426, which applies as from 21 April 2018 and are manufactured in accordance with the harmonised European standards; EN 30-1-1:2008+A3:2013 & EN 30-2-1:2015;

Satisfy the essential requirements of the Low Voltage Directive 2014/35/EU, where applicable and are manufactured in accordance with the harmonised European standards; EN 60335-1 (IEC 60335-1:2010); EN 60335-2-6 (IEC 60335-2-6:2002 +A1:2004 +A2:2008); EN 60335-2-102 (IEC 60335-2-102:2006 +A1:2010);

Satisfy the essential requirements of the Electro Magnetic Compatibility Directive 2014/30/EU and are manufactured in accordance with the harmonized European standards; EN 55014-1: 2006 + A1:2009 + A2:2011 & EN55014-2: 1997 + A1:2001 + A2: 2008; EN 61000-3-2:2006 +A1:2009 & EN 61000-3-3:2013 where applicable;

We also declare that the production of each specific model will be in conformity with the type as described in the EC type-examination certificate;

CE 680544, Issued by BSI

We also declare that the production of each specific model will be in conformity with the type as described in Test Report(s):

8515933, 8432405, TR 14/404 & TR 15 049 as applicable, Issued by BSI

Name : **Bartho Anderson**
Title/Position : **Director**
Place & Date of Issue : **Rotherham 23rd February 2018**

Signature :



EN

Original User Manual

Contents

1	Introduction.....	2
2	Symbols.....	2
3	Safety.....	3
4	Main components.....	6
5	Before use.....	7
6	Use of the burners.....	7
7	Use of the electric hotplate (if applicable).....	8
8	Safe cooking.....	9
9	Maintenance and cleaning.....	10
10	Gas leaks.....	10
11	Troubleshooting.....	11
12	Servicing.....	11
13	Putting in storage.....	11
14	Technical specifications.....	12
15	Disposal.....	13
16	Questions.....	13
17	Warranty.....	13

1. Introduction

This is the user manual for your Thetford hob. Read the safety instructions and information on use and maintenance of the hob carefully before continuing. This will enable you to use the hob safely and efficiently. Retain this manual for future reference.

For the latest version of this manual, please visit www.thetford.com.

2. Symbols

Key to symbols:



Warning. Risk of injury and/or damage.



Caution. Hot surface. Risk of injury and/or damage.



Attention. Important information.



Note. Information.

3. Safety

EN



This appliance may be used by children aged 8 years or older and persons with reduced physical, sensory or mental capabilities and/or lack of experience and knowledge only if they are supervised or have been given instructions on the safe use of this appliance and understand the potential hazards.



Keep children younger than 8 years away from the appliance, except under constant supervision.



Do not allow children to play with the appliance.



Do not allow children to clean or maintain this equipment unattended.



Use only parts supplied by the manufacturer.



Do not change or adjust anything on the appliance, unless the change is authorised by the manufacturer or its representative.



Use the appliance for cooking only and not for anything else, for example room heating. This can lead to carbon monoxide poisoning and overheating. The manufacturer cannot be held liable for damage resulting from improper use or incorrect setting of the controls.



This appliance is not intended to be operated by means of an external timer or separate remote-control system.

The use of this gas cooking appliance results in the production of heat, moisture and products of combustion in the room in which it is installed.



Ensure the room has sufficient ventilation when the appliance is in use. During prolonged use, additional ventilation may be needed by opening a window or increasing the extraction force of the hood.



Never extinguish a cooking fire with water. Turn the burner off and cover the flame with a lid or a fire blanket.



The burners and pan supports are hot during and after use. Allow all parts to cool before touching them, as this can cause serious injury.



Unattended cooking on a hob with fat or oil can be dangerous and may result in fire. Do not leave the appliance unattended when in use.



The use of inappropriate hob guards can cause accidents.



Do not store items on the cooking surface of the hob.



Do not use steam cleaners or pressure washers to clean the appliance. See Maintenance and cleaning for instructions.



Do not allow oil or fat to build up on the appliance. Clean the appliance after each use.



The glass lid may snap shut towards the end of lowering due to the travel-lock action of the hinges. Make sure all fingers are clear of the appliance when closing the lid.



Do not use harsh abrasive cleaners or sharp metal scrapers to clean the surface of the glass, since they can scratch the glass surface which may result in shattering of the glass.



Remove any spillage from the glass lid before opening the lid.



Do not shut the glass lid when the burners are lit or still warm.



4. Main components

SHB140/SHB142/SHB144

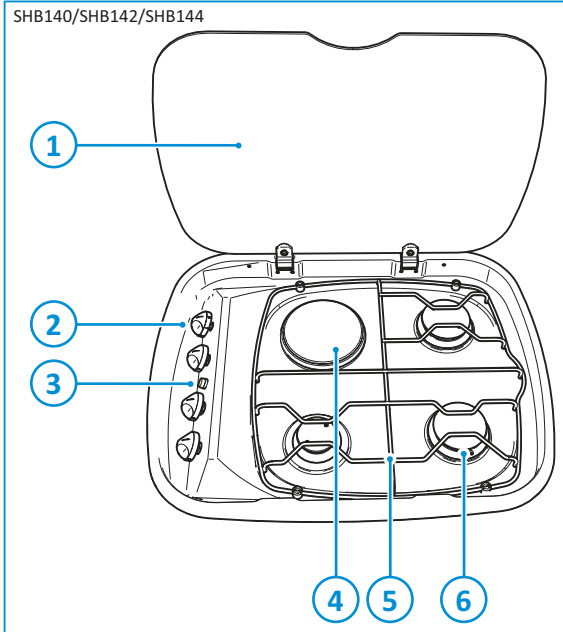

1. Lid (optional)
2. Control panel
3. Spark ignition (optional)
4. Electric hotplate (SHB142)
Gas burner (SHB140/
SHB144)
5. Pan supports
6. Gas burners

SHB143/SHB145

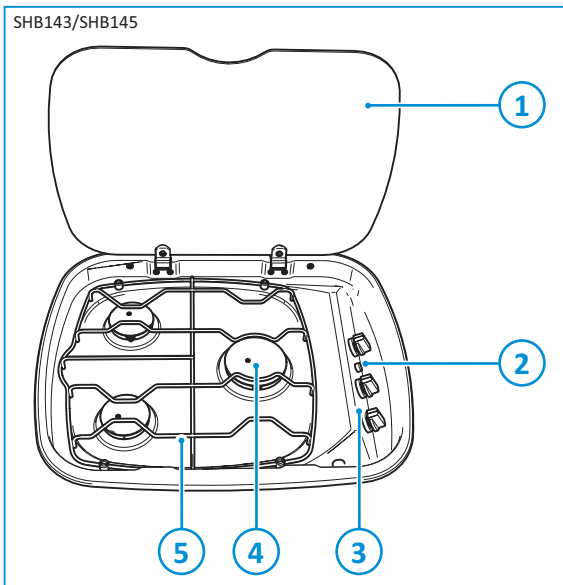

1. Lid (optional)
2. Spark ignition (optional)
3. Control panel
4. Gas burners
5. Pan supports

The types of burners may vary depending on the type of appliance. Refer to Technical specifications for further details.

5. Before use

Before using the appliance:

- Ensure that all packaging materials have been removed.
- Clean the appliance with warm water and household detergent and dry carefully with a soft cloth.
- Ensure that the gas supply is connected and turned on.
- For ignition models: Ensure that the appliance is connected to the 12V DC battery for the spark ignition.
- Ensure that the pan supports are positioned properly.
- Ignite the gas burners and let them burn to expel odours and vapours first.

Dual Fuel only:

- Ensure the electricity is connected and switched on.
- Prime the hotplate by switching on the hotplate for a short period, without a pan, to harden and burn off the coating. Use a medium to high setting for 3 – 5 minutes. Allow adequate ventilation to disperse any smoke that occurs during this process. Allow the hotplate to cool.
- Season the hotplate by heating the hotplate for 30 seconds on a medium setting and then switching off. Pour a minimal amount of unsalted vegetable oil onto a clean dry cloth or paper towel, and apply a thin coat of oil to the hotplate surface. Wipe off any excess oil, then heat the hotplate on a medium setting for 1 minute. Occasional seasoning will help to maintain the hotplate's appearance.



Only use LPG (Liquefied Petroleum Gas). The appliance operates on propane or butane. Propane is preferred over butane, because butane provides poor performance at an ambient temperature below 10°C and cannot be used at an ambient temperature below 5°C.

6. Use of the burners

For the exact location of the control knobs, see Main components.

Turning on:

- Push and turn the control knob.
- Turn the control knob anti-clockwise to the full rate position.
 - For models fitted with standard ignition: Push the ignition button.

- For non-ignition models: Hold a lit match or gas match to the burners.
- Keep the control knob pressed for about 10-15 seconds and then release it.
- Adjust the height of the flame.



If the burner accidentally extinguishes turn the control knob to the 0 position and wait at least 1 minute before re-igniting the burner.



If the burner has not lit within 15 seconds turn the control knob back to the 0 position and release it. Wait at least 1 minute and repeat the steps above to turn on the appliance.

Turning off:

- Turn the control knob clockwise to the 0 position to turn off the burner.



Always make sure the control knob is in the 0 position when you have finished using the gas burners.



Do not shut the glass lid when the burners are lit or still warm.

7. Use of the electric hotplate (if applicable)

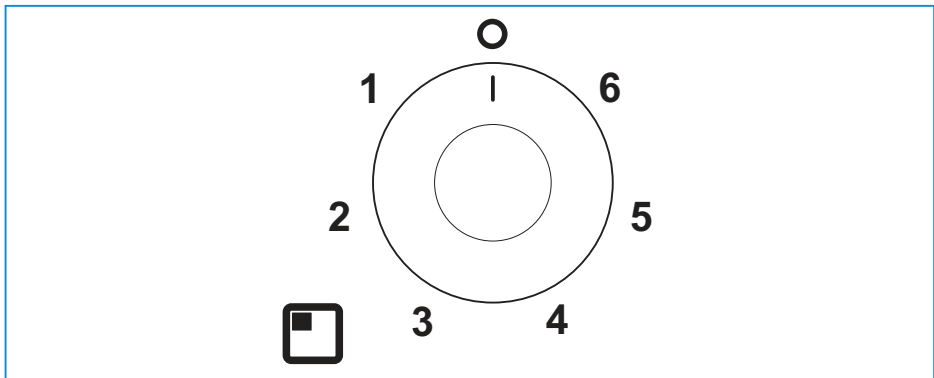

For the exact location of the control knob, see Main components.

Turning on:

- Rotate the control knob either clockwise or anti-clockwise to the required position (1 – 6).



For maximum efficiency, a correctly sized pan with a flat heavy gauge base should be used. The pan size should be the same or slightly larger than the hotplate (up to 1" / 2.5cm oversize).

Turning off:

- Turn the control knob to the 0 position to turn off the hotplate.



Always make sure the control knob is in the off position when you have finished using the hotplate.



Do not shut the glass lid when the hotplate is turned on or still warm.

8. Safe cooking

- Do not allow cooking vessels to overlap the edges of the appliance – use the correct sizes of pans and position them centrally over the burners.

SHB140/SHB144

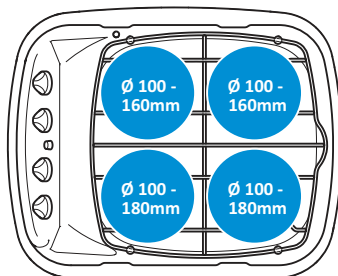

SHB142

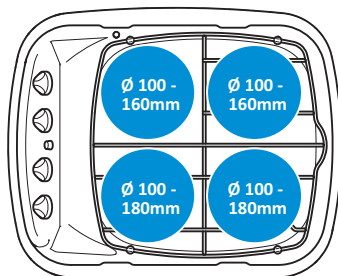

SHB143

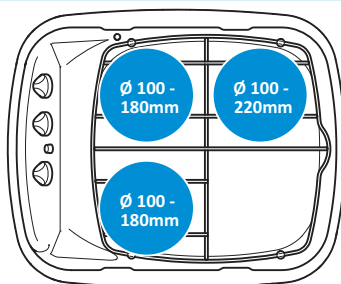

SHB145

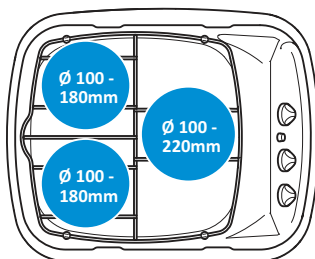

EN

- Ensure that there is at least a 10mm gap between the pans and the edges of the hob.
- Turn the pans so that the handles do not overhang the front of the appliance.
- Ensure that the flame of the gas burner heats the bottom of the pan, not the sides.
- Do not leave the appliance unattended when in use.
- Do not use the appliance while the vehicle is moving.
- Turn the control knob back to the 0 position after cooking.
- Keep the appliance clean and prevent accumulation of grease and food scraps.

9. Maintenance and cleaning

Thetford recommends an annual inspection service by an approved service centre. Between annual servicing, clean the appliance regularly after use. Before any cleaning work is started, the appliance should have been left to cool and be disconnected from the gas and electrical supplies.

- Always remove any spills or contamination immediately after use with soap and hot water. Towel dry the surface with a soft cloth.
- Use a non-abrasive multi-purpose cream cleaner and a nylon scourer pad to clean more stubborn dirt or grease.



Do not use abrasive cleaners, metal scouring pads or hard brushes. They could damage the appliance.



If you clean the burner rings, ensure that the holes are not clogged.



Remove any spillage from the glass lid before opening the lid.



The control knobs can be removed for cleaning. The knobs are easy to replace.

10. Gas leaks

As soon as you smell gas:

- Ensure that all burners are turned off.
- Extinguish all naked lights and do not smoke.
- Shut off the gas supply at the gas bottle immediately.
- Do not use electrical switches.
- Open all doors and windows.



LPG is heavier than air. Escaping gas accumulates at lower levels. By following the strong, unpleasant smell of gas, you can determine where the leak is located. To investigate where it is exactly, use a special leak detection spray. Never use an open flame to find the leak!

11. Troubleshooting

Problem	Possible cause	Solution
Burners do not burn or burn unevenly	Gas bottle is empty Gas tap is closed Burner caps are not correctly positioned Burners are wet or clogged	Change gas bottle Open tap Allow caps to cool, then re-position them Dry or clean burners
Spark ignition does not spark	12V DC battery is discharged Connections are loose Ignition points are wet or dirty	Charge battery Secure connections Dry or clean ignition points
Control knobs do not function	Knobs are mounted incorrectly	Install knobs correctly

EN



If you cannot solve a problem, contact the authorised local Service Centre or Thetford Customer Service in your country.

12. Servicing

All servicing must be carried out by an approved competent person. Before any service work is started, the appliance should have been left to cool and be disconnected from both the gas and electrical supplies. After each service the appliance must be checked for gas soundness and electrical safety.

For service, please contact your authorised local Service Centre giving details of the model and serial number on the data badge plus date of purchase.







Model Name & Series Number				
G30 G31	CAT I ₃ + (28-30/37) BUTANE 28-30mbar PROPANE 37mbar	CAT I ₃ B/P(30) BUTANE 30mbar PROPANE 37mbar	THETFORD	
ΣQn	Power kW (g/hr)	Model Number	Spark Ignition	
CE	Pin Number	Serial Number	Voltage ~ 50 Hz	
Country Codes 1		Country Codes 2	QC Pass	Order No







13. Putting in storage

- Close the gas valve at the gas bottle.
- Dual Fuel only: Disconnect the electrical supply.
- Spark ignition models only: Disconnect the battery.
- Ensure that the control knobs are in the 0 position.
- Close the lid, if present.
- Wipe the appliance clean and dry.

14. Technical specifications

Table 1: Burner specifications

	SHB140/SHB144 series			SHB142 series		
	Gas input		Injector	Gas input		Injector
						
	kW	g/hr	mm	kW	g/hr	mm
Gas burners	4 x 1.5	4 x 108	0.61	2 x 1.5 1 x 1.0	2 x 108 1 x 72	0.61 0.52
Hotplate burner				1 x 800W 230V ~ AC 50Hz		
Total	6.0	432		4.0 (gas) 800W (electric)	288	

	SHB143 series			SHB145 series		
	Gas input		Injector	Gas input		Injector
						
	kW	g/hr	mm	kW	g/hr	mm
Gas burners	3 x 1.5	3 x 108	0.61	2 x 1.5 1 x 2.4	2 x 108 1 x 173	0.61 0.77
Total	4.5	324		5.4	389	



This appliance is suitable for use with LPG (Liquefied Petroleum Gas) and should not be used with any other gas.



This appliance must be earthed.

Energy consumption measurement and calculations in accordance with EN60350-2 2013

Theftord appliance model identification	Cooking zones	Type of hob (watt)	Diameter of cooking zone	Energy consumption EC _{electric hob} Wh/kg
Argent Dual-Fuel Hobs SHB142XX Series	1	800W solid hotplate	115mm	190.0

To reduce energy use on the hob while cooking:

- Use the correct size of pan – a pan which fits the hotplate will use less energy than one that is too large or too small.
- Use the minimum heat setting to maintain simmering or boiling – additional heat is just wasted.
- Cover pans or kettles with a lid whenever possible – this helps to retain heat.

- Do not use old, damaged or distorted pans, they will reduce efficiency.

15. Disposal

Your product has been designed and manufactured with high quality materials and components, which can be recycled and reused. When your product has reached its end of life, dispose of the product according to the local rules. Do not dispose of the product with the normal household waste. The correct disposal of your old product will help prevent potential negative consequences to the environment and human health.

16. Questions

EN

If you have questions about your product, parts, accessories or authorised services:

- Visit www.thetford.com.
- If you cannot solve a problem, contact the authorised local Service Centre or Thetford Customer Service in your country.

17. Warranty

For our warranty clause, please refer to the conditions mentioned on www.thetford-europe.com/service/warranty. For more information, please contact the Thetford Customer Service in your country.

EUROPEAN HEADQUARTERS

Thetford B.V.
Nijverheidsweg 29
P.O. Box 169
4870 AD Etten-Leur
The Netherlands

T +31 76 504 22 00
F +31 76 504 23 00
E info@thetford.eu

FRANCE

Thetford S.A.R.L.
Parc BUROPLUS / Bâtiment 6
18, Boulevard de la Paix
95800 CERGY
France

T +33 1 30 37 58 23
F +33 1 30 37 97 67
E infof@thetford.eu

SCANDINAVIA

Thetford B.V.
Representative Office Scandinavia
Hantverkaregatan 32D
521 61 Stenstorp
Sverige

T +46 31 336 35 80
F +46 31 44 85 70
E infos@thetford.eu

UNITED KINGDOM

Thetford Ltd.
Unit 6
Brookfields Way
Manvers, Rotherham
S63 5DL, England
United Kingdom

T +44 844 997 1960
F +44 844 997 1961
E infofgb@thetford.eu

ITALY

Thetford Italy c/o Tecma s.r.l.
Via Flaminia
Loc. Castel delle Formiche
05030 Otricoli [TR]
Italia

T +39 0744 709071
F +39 0744 719833
E infoi@thetford.eu

AUSTRALIA

Thetford Australia Pty. Ltd.
41 Lara Way
Campbellfield VIC 3061
Australia

T +61 3 9358 0700
F +61 3 9357 7060
E infoau@thetford.eu
www.thetford.com.au

GERMANY

Thetford GmbH
Schallbruch 14
D-42781 Haan
Deutschland

T +49 2129 94250
F +49 2129 942525
E infod@thetford.eu

SPAIN AND PORTUGAL

Mercè Grau Solà
Agente para España y Portugal
c/ Castellet, 36 bxs 2ª
08800 Vilanova i la Geltrú
Barcelona
España

T +34 938 154 389
F not available
E infoesp@thetford.eu

CHINA

Thetford China
Rm. 1207, Coastal Building
(East Block)
Haide 3rd Road, Nanshan District
Shenzhen, 518054
China

T +86 755 8627 1393
F +86 755 8627 1673
E info@thetford.cn
www.thetford.cn